

WANG

III.H.10M-1

**CUSTOMER ENGINEERING REPRINT
FOR RACAL-VADIC
MODEL VA3450 MODEM**

Racal-Vadic

VA3450 SERIES

**INSTALLATION/OPERATION
MANUAL**

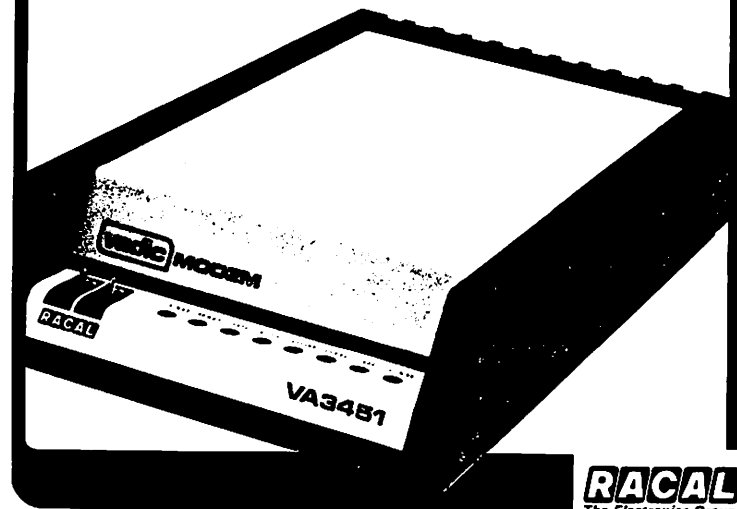

Publication No. 18008-047

RACAL
The Electronics Group

JULY 1981

**REORDER NUMBER
729-0997**

WANG

III.H.10M-1

CUSTOMER ENGINEERING REPRINT

**PRODUCT MAINTENANCE MANUAL
FOR RACAL-VADIC
MODEL VA3450 MODEM**

JULY 1981

**REORDER NUMBER
729-0997**

TABLE OF CONTENTS

SECTION 1	GENERAL INFORMATION	1-1
SECTION 2	INSTALLATION	2-1
	INTRODUCTION	2-1
	PRELIMINARY PROCEDURES	2-1
	Unpacking and Inspection	2-1
	Equipment Required	2-1
	Switches and Straps	2-2
	Preinstallation Checks	2-2
	INSTALLATION PROCEDURE	2-3
SECTION 3	OPERATION	3-1
	CONTROLS AND INDICATORS	3-1
	OPERATING PROCEDURES	3-4
	Manual Originate	3-4
	Manual Answer	3-5
	Automatic Answer	3-5
SECTION 4	TESTING	4-1
	ALB TEST	4-1
	DLB TEST	4-2
	SERVICE CENTERS	4-3
SECTION 5	OPTIONS	5-1
	SWITCH OPTION DESCRIPTION	5-5
	SOLDER STRAP DESCRIPTION	5-6
	NO OPTION MODE	5-7
SECTION 6	SUPPLEMENTAL INFORMATION	6-1
	THEORY OF OPERATION	6-1
	Data Terminal Equipment Interface	6-1
	TelCo Line Interface	6-1
	SPECIFICATIONS	6-4

LIST OF TABLES

Table 2-1	Telephone (TelCo-Supplied) Options	2-2
Table 3-1	Controls and Indicators	3-2
Table 5-1	Switch and Strap Options	5-2
Table 6-1	RS232C Modem Interface Connector	6-2
Table 6-2	TelCo Interface Cable	6-3

LIST OF FIGURES

Figure 2-1	VA345xP Connection to Data Jack	2-4
Figure 2-2	VA345xP/VA871 Voice or Data Jack Configuration	2-4
Figure 2-3	VA3453G Leased-Line Configuration	2-5
Figure 3-1	Controls and Indicators	3-1
Figure 4-1	ALB Test Diagram	4-1
Figure 4-2	DLB Test Diagram	4-2
Figure 5-1	VA345x Switch and Strap Locations	5-4

Section 1

GENERAL INFORMATION

This manual contains installation, operation, and service information for the VA3451,52,53P/S/G family of microprocessor-controlled, full-duplex modems.

Throughout this manual the modem, as a series, will be referred to as the VA345x, unless a specific model is referenced. The "x" may be substituted with a 1, 2, or 3 depending on your model. The VA345x modem is available in the following line interface configurations:

VA345xP Provides permissive direct connection to a data or voice jack with a 6-pin plug

VA345xS Provides programmable direct connection to a data jack with an 8-pin plug

VA3453G Provides connection to a 2-wire leased-line facility

The specific VA345x modem is compatible with the operating modes shown below. In each case both the originate and answer mode are provided.

Model Number	Bell		Racal-Vadic
	103	212A	3400
VA3451P/S	X	X	X
VA3452P/S		X	X
VA3453P/S	X		X
VA3453G	X		X

Section 2

INSTALLATION

INTRODUCTION

This section provides installation and operational checkout procedures for the VA345x modem. In case of difficulty during any of the following procedures, reference the testing instructions in Section 4.

CAUTION

Procedures in this section should be performed in the sequence and manner prescribed. Any deviation may damage the equipment.

PRELIMINARY PROCEDURES

Unpacking and Inspection

Inspect the shipping carton immediately upon receipt. If the carton has been damaged, request that the carrier's agent be present during unpacking. Inspect the contents for physical damage and/or missing parts. If the contents have been damaged, or parts are missing, immediately notify the nearest RACAL-VADIC sales office. The sales office will arrange for repair or replacement without waiting for settlement of any claim against the carrier.

Equipment Required

One of the following three jacks, supplied by TelCo and ordered by the Universal Service Ordering Code (USOC), must be specified for use with the modem:

RJ11C/RJ11W	VA345xP only
RJ41S (data jack)	VA345xP or VA345xS
RJ45S (data jack)	VA345xP or VA345xS
Leased-Line Block	VA345xP with VA881 adapter

The VA345xP modem and optional VA871 VADICphone have attached direct-connect cables terminating in miniature 6-position modular plugs. The plugs are compatible with the RJ11C voice jack and the RJ45S data jacks supplied by TelCo. The TelCo Data Phone USOC is RTC 503 for rotary dial or RTC 2503 for touch-tone dial. When ordering the phone, the phone company will ask what options are desired. Determine your mode of operation in Table 2-1 below and order the corresponding options (A1 to D8). The data phone may only be ordered with an RJ41S or RJ45S data jack.

Table 2-1. Telephone (TelCo-Supplied) Options

Telset	Modem	
	Manual Ans Manual Orig	Manual Orig Auto Ans
Touch-Tone	A1, B3 C5, D7	A2, B3 C5, D7
Rotary	A1, B3 C6, D7	A2, B3 C6, D7

Note: Options B4 and D8 are not applicable.

**Switches
and Straps**

The modem is shipped with switch and strap settings as required per standard factory setting. If changes are required to the option selections, refer to Section 5 of this manual.

**Preinstallation
Checks**

Prior to installation, a few precautionary measures should be taken to ensure system integrity:

1. Verify that proper TelCo equipment has been installed for the type of modem being installed. The terminal block should correspond to the modem as shown above under Equipment Required.

NOTE

Although not specifically designed for the application, a VA345xP modem may be plugged into, and used with, an RJ41S or RJ45S data jack.

2. Read through the installation procedures to verify that all required equipment, material, and tools are available.
3. Perform the procedures in the following order:
 - a. Verify switch and strap options provided in Section 5.
 - b. Verify required TelCo equipment is provided.
 - c. Perform installation procedures below.
 - d. Perform testing procedures in Section 4.

CAUTION

Procedures in this section should be performed in the sequence and manner specified. Any deviation may damage the equipment.

INSTALLATION PROCEDURE

To connect to the phone line, simply insert the modular plastic connector on the end of the TelCo line cable into the receptacle provided by the TelCo. If used in a leased-line configuration, connect the VA881 leased-line adapter to the leased-line terminal block and insert the plastic connector into the VA881 adapter. The VA881 adapter fits over a standard TelCo-supplied 40-series mounting block.

To connect to the Data Terminal Equipment (DTE), insert the cable from the DTE into the connector on the back of the modem. This cable is normally supplied with the DTE. Where provided on the cable connector, tighten the two screws to hold the connector securely in place. To provide power, plug the attached transformer plug assembly into the wall. The cover plate screw may be used to secure the unit to the outlet.

NOTE

Prior to connecting any device to the switched telephone network, Federal Communications Commission (FCC) regulations specify that the customer must provide the telephone company with the name of the manufacturer (RACAL-VADIC), equipment model numbers, FCC registration numbers, and ringer equivalence numbers of the devices to be used. This information is listed on the equipment and also listed below.

Model VA345xP or VA345xS
FCC Registration No:
AJ496M-67213-DM-N
Ringer Equivalence: 0.9B

Figure 2-1 shows a VA345xP or S connected to a data jack. The telephone is supplied by TelCo. This installation is capable of manual originate and manual or auto answer depending on how the phone is optioned (to be done by TelCo).

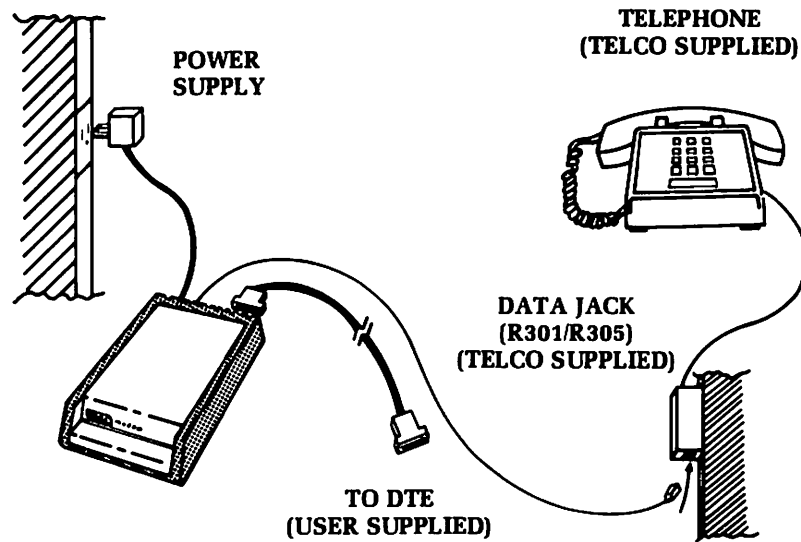

Figure 2-1. VA345xP Connection to Data Jack

Figure 2-2 shows a VA345xP connecting to a VA871 VADICphone. The VA871 will interface to a voice or data jack. This installation is capable of manual originate and automatic or manual answering depending on how the phone is optioned. Refer to the VA871 manual for phone options.

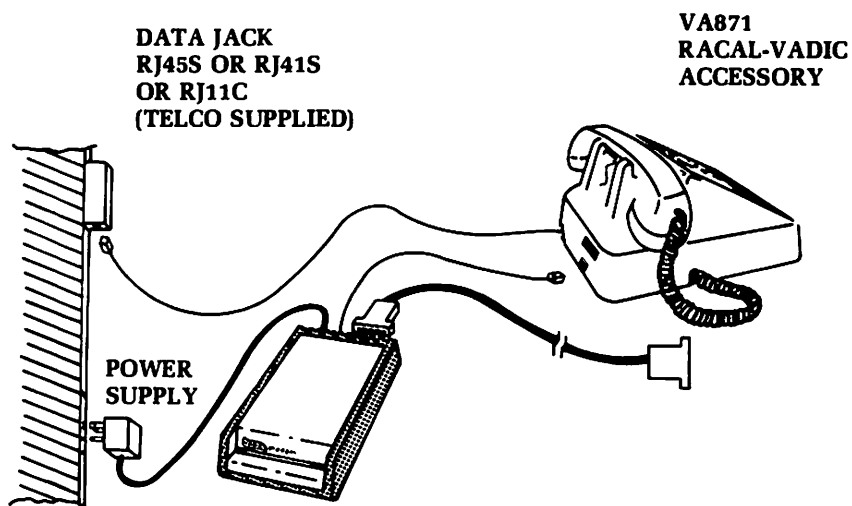

Figure 2-2. VA345xP/VA871 Voice or Data Jack Configuration

Figure 2-3 shows a VA3453G connected to a VA881 adapter to allow connection to a screw-type terminal for leased-line interface. On a leased line, one modem must be in originate and the other in answer mode.

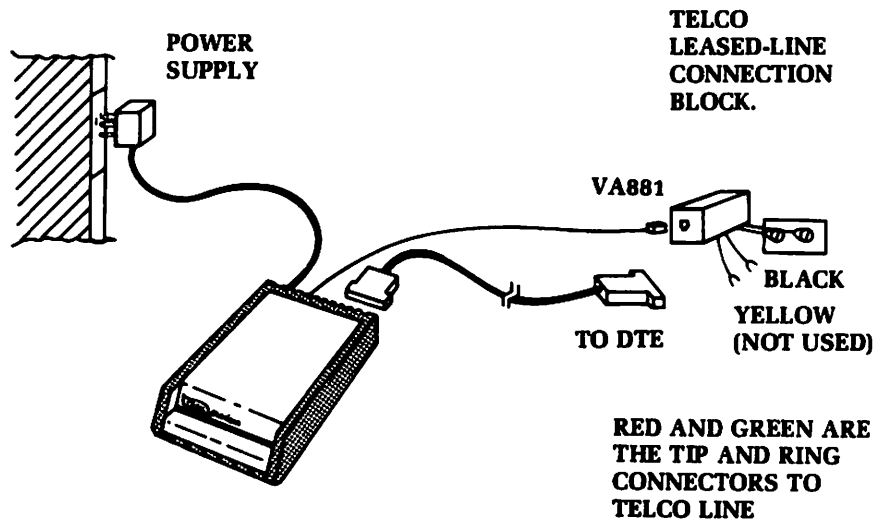
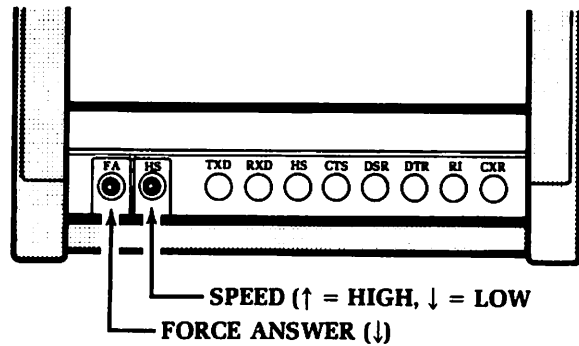

Figure 2-3. VA3453G Leased-Line Configuration

Section 3 OPERATION

CONTROLS AND INDICATORS

Figure 3-1 shows the location of the controls and indicators. Table 3-1 contains a listing of the controls and indicators and their functions.



a) FRONT VIEW

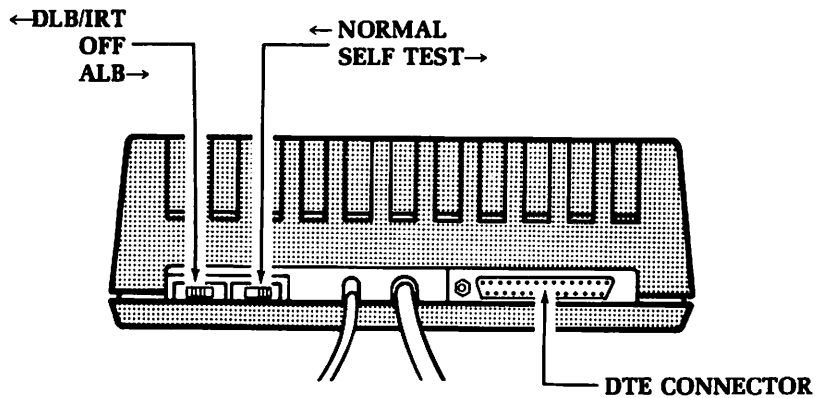

b) REAR VIEW

Figure 3-1. Controls and Indicators

Table 3-1. Controls and Indicators

Controls/Indicators	Function
Front Panel	
FA (FORCE ANSWER)	This switch is used to force the modem into the answer mode. When the telset is controlling the modem (manual answer mode), this switch must be used after answering the telephone to force the modem answer tone and mode.
HS (HI/LO SPEED)	This switch sets the speed of the modem, when in the originate mode, to either high speed (3400/212) or low speed (103). This switch will not affect the speed of the modem in the answer mode, since this is controlled by the calling modem. The speed selection must be made before lifting the handset to originate a call.
TXD	Transmit Data—This lamp is lit when spacing data is being transmitted from the local DTE to a remote modem.
RXD	Receive Data—This lamp is lit when spacing data is being received at the local DTE from a remote modem.
HS	High Speed—This lamp is lit when the modem is in the 3400/212 mode and off when the incoming data is in 103 mode.
CTS	Clear to Send—When ON, this lamp indicates that the modem is ready to accept data from the DTE.
DSR	Data Set Ready—When ON, this lamp indicates that the modem is connected to the TelCo line. This lamp will flash when the modem is in a test mode.

Controls/Indicators	Function
DTR	Data Terminal Ready—When ON, this lamp indicates that the DTE is ready, connected to the modem (or B2 is ON).
RI	Ring Indicator—When ON, this lamp indicates that the modem is receiving a ring signal from the TelCo line. This lamp will also flash twice per second whenever the modem fails the idle test or self-test.
CXR	Carrier Detect—When ON, this lamp indicates that a valid carrier is being received from the far-end modem, or the modem is in the ALB(test) mode.
Rear Panel	
NORMAL (left) SELF TEST (right)	This switch sets the modem to the self-test mode, causing the modem to generate a dotting pattern in the high speed mode and a mark/space pattern in the low speed mode. This is used in conjunction with the switch below.
DLB or IRT (left) OFF (center) ALB (right)	This switch, in the DLB/IRT position, operates in conjunction with internal option switch B1. When B1 is ON, setting the switch to the DLB/IRT position Initiates Remote Test. When B1 is OFF, setting the switch to the DLB/IRT position initiates local digital loopback. When the modem is in the low speed mode, it goes into local digital loopback regardless of the position of switch B1. When the switch is set to the ALB position, the modem is set in an analog loopback mode that loops the output of the transmitter back into the receiver. The SELF TEST switch (above) is then turned on to generate a test pattern.

OPERATING PROCEDURES

The following operating procedures apply when the modem has standard switch and strap options selected (modems are shipped with standard options implemented unless otherwise requested). On the front-panel displays, shown in the following paragraphs, the indicators are represented as follows:

● = ON, ○ = OFF, ● = flashing/blinking, ⊗ = may be either state.

Manual Originate

1. Set speed on front panel to proper speed for data terminal on far end. Low speed is 103 compatible; high speed (HS) is 212/3400 compatible.
2. Lift telephone handset and set phone in voice mode. This is normally done with an exclusion key on the phone, or with a separate voice/data switch. The following display will be present:

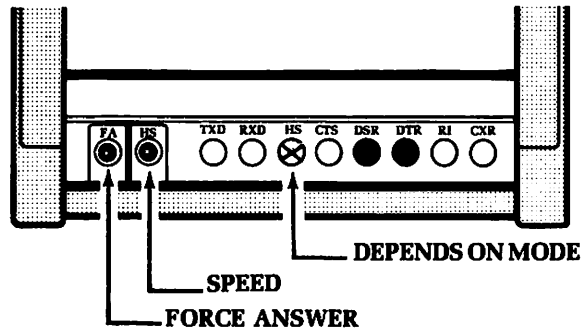

3. Listen for dial tone and then dial number of far-end modem.
4. When you hear a tone (answer tone from far-end modem), set phone in data mode. This will be done with the same key or switch as used in step 2 above. When CTS turns ON, data may be exchanged. The following display will be present:

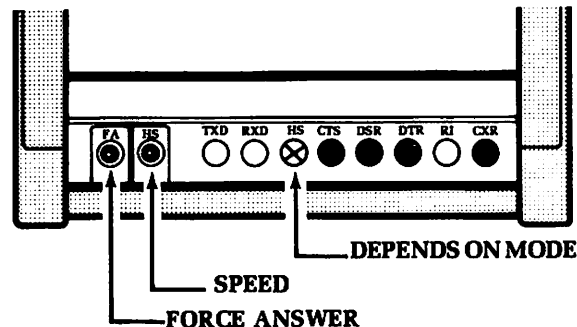

- During the data exchange, the following display will be present:

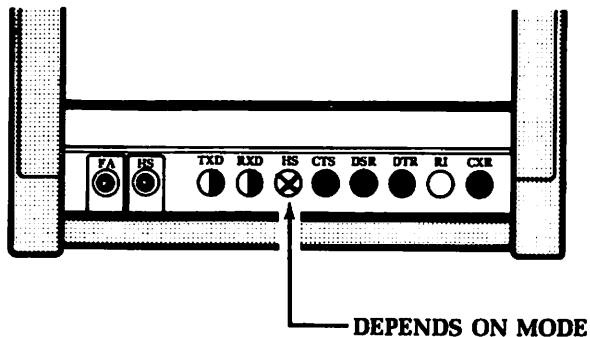

- When data communication is completed, replace handset in cradle, and set voice/data switch to voice (if used). DTR should stay lit, and RI will flash until the modem disconnects.

Manual Answer

- When telephone rings, lift handset and establish voice communications. DTR lamp should be on. When handset is lifted from cradle, the DSR indicator will turn ON.
- When ready to transfer data, set telephone to data mode. This is normally done with an exclusion key on the telephone, or with a separate voice/data switch. If using a separate voice/data switch, DSR will now turn ON. Next, activate Force Answer (FA) switch on front of modem. This is done by pulling the switch toward you. Wait for the CXR and CTS indicators to come on.
- During the data exchange, the following display will be present:

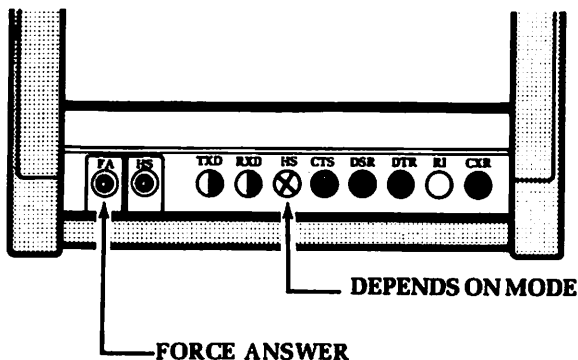

- When data communication is completed, replace handset in cradle, and set voice/data switch to voice (if used).

Automatic Answer

The modem will automatically select the proper speed (mode) and respond to the calling unit. The data display will be the same as above, except that DTR must be on, before receiving the ring signal, to automatically answer an incoming call.

Section 4 TESTING

In the event of a communication failure, perform the following Analog Loopback (ALB) and Digital Loopback (DLB) tests to isolate the problem. The ALB test checks the operation of the modem; the DLB test checks the operation of both modems and the communications link (TelCo lines). On the front-panel displays, shown in the following paragraphs, the indicators are represented as follows:

● = ON, ○ = OFF, ● = flashing/blinking, ⊗ = may be either state.

ALB TEST

A block diagram of the ALB test circuit is shown in Figure 4-1.

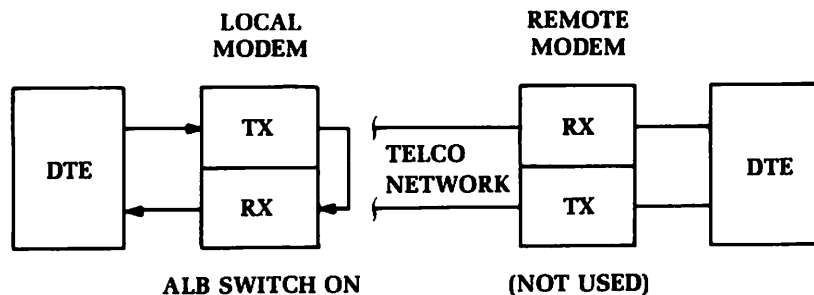

Figure 4-1. ALB Test Diagram

DISCONNECT FROM PHONE & WORKS

The ALB test checks the local end of the communications link. It is initiated by setting the ALB/DLB switch on the rear panel of the modem to the ALB position. This isolates the modem from the telephone line and connects the transmitter output to the receiver input. The modem must be on hook to perform the ALB test.

Perform the ALB test as follows:

1. Set SPEED switch on front panel to high speed (HS) position.
2. Set switch on rear panel to ALB position.
3. Set switch on rear panel to SELF TEST position.
4. DSR indicator will flash indicating unit is in test mode.
5. CXR, TXD, RXD, and HS indicators will be ON.

6. The following display should be present:

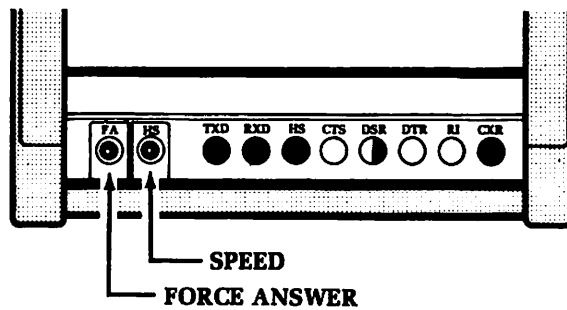

7. RI will flash continuously if error occurs. In this event contact your RACAL-VADIC distributor or the RACAL-VADIC regional office nearest you.
8. If no error occurs, set rear-panel switches to NORMAL (left position) and OFF (center position).
9. Set speed switch on front panel to low-speed position.
10. Repeat steps 2 through 7 above (HS will be OFF).

DLB TEST

A block diagram of the DLB test circuit is shown in Figure 4-2.

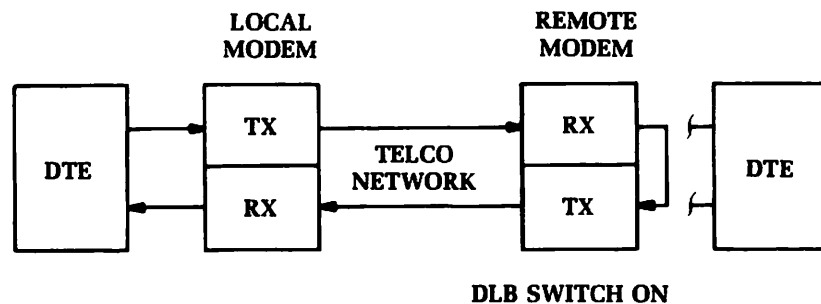

Figure 4-2. DLB Test Diagram

The DLB test checks the local modem and/or the remote modem plus the TelCo line. This can be enabled in two ways. Either the operator at the remote modem can set the modem to the DLB mode, or the local modem can send a signal telling the remote modem to respond to remote test (RTRT). This is done on the local modem with the ALB/DLB switch.

Setting the ALB/DLB switch to the IRT/DLB position in the HS mode provides either a digital loopback of the incoming signal or initiates remote test. The function of this switch depends on the setting of switch B1 and A6. If switch A6 is OFF or switch B1 is ON, the switch will select IRT. This causes the modem at the far end (if so equipped) to go into the DLB mode. Turning on the SELF TEST switch applies a test signal to the transmitter. If switch A6 is ON and switch B1 is OFF, the ALB/DLB switch will force the modem into

the local DLB mode, looping a signal from a remote modem around and sending it back. In the LS (low speed) mode, the modem will enter a local digital loopback, which may be used to test the DTE.

Perform the DLB test as follows:

1. Set far-end modem for DLB.
2. Make sure internal switch A6 is OFF.
3. Set speed switch on front panel to HS position.
4. Set switch on rear panel to IRT/DLB and SELF TEST.
5. DSR will flash; DTR, HS, CXR, and CTS indicators will light.
6. The following display should be present:

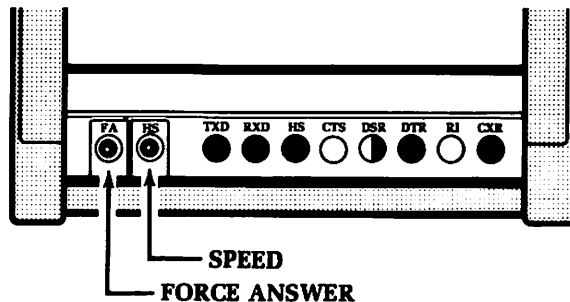

7. RI indicator will flash if an error occurs.
8. Repeat steps 2 through 7 with the speed switch in the low-speed position.

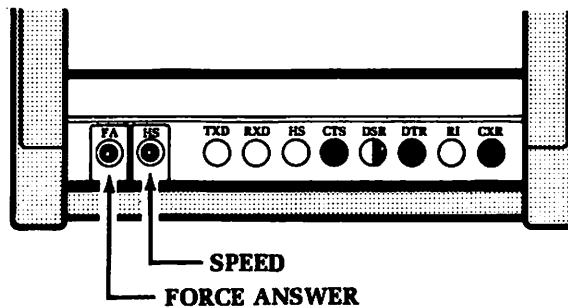

9. Set switches to OFF and NORMAL when finished.

If the RI indicator flashes, and the ALB test was good, the problem is in the far-end modem or in the telephone line. Ask the far-end operator to perform the ALB test. If the problem is in the modem, substitute another unit to verify correction of the problem.

**SERVICE
CENTERS**

If the trouble is not solved by checking any of the previous steps, contact the nearest RACAL-VADIC Regional Diagnostic Center listed on the back cover.

Section 5

OPTIONS

The modem is delivered strapped for normal operation. Changes to the basic configuration can be made by determining your special requirements, comparing them against the following tables, and selecting the appropriate switch and strap options. Figure 5-1 shows the switch and strap locations. The top cover is removed by pressing in on each side and lifting. Be sure the unit is unplugged from both the telephone line and the power source while the cover is removed. Table 5-1 shows the available switch and strap options. The following paragraphs discuss each of these options.

NOTE

To use nonstandard switch and strap options, switch A6 must be ON, disabling the "standard settings" option. This requires that all settings covered by this option be checked.

Table 5-1. Switch and Strap Options

Switch	Function	Enabled Position	Normal Position
A1*	Unattended Disconnect	Off	On
A2*	Respond To Remote Test	On	On
A3*	Character Length (see description)	—	On
A4*	Inhibit 103 Operation (VA3451 and VA3453 only)	Off	On
A5*	Character Length (see description)	—	Off
A6	Standard Options	Off	On
A7*	Carrier Loss Disconnect	On	On
B1*	Enable Initiate Remote Test	On	On
B2*	Force DTR	On	Off
B3*	Answer Only	On	Off
B4*	Select 1220 bps	On	Off
B5*	Enable Abort Timer	On	On
B6*	Synchronous Operation	On	Off
B7*	Force DSR Off In Test (IRT)	On	Off
W1	Full Amplitude Equalizer	In	Out
W2	Phase Equalizer	In	Out
W3	Testing Equalizer	In	Out
a*	Leased-Line Mode (VA3453 P/G only)	In	Out
b*	Disconnect On Received Space (Bell 103 and 212 only)	Out	In
c*	Transmit Space Before Disconnect (Bell 103 and 212 only)	Out	In
d	Slave Clock	In	Out
e	Select 0 dBm Transmit Level (VA3453G leased line only)	In	Out
f	CXR to DTE Pin 8 (Strap g must be out)	In	In

Table 5-1 (cont'd)

Switch	Function	Enabled Position	Normal Position
g	CTS to DTE pin 8	In	Out
h*	Inhibit RXD During RTRT (Strap w must be out)	In	In
j*	External Clock Slave	In	Out
k*	Speed Selection From DTE	In	Out
l	Transmit Level Control (-10 dBm) (Strap e must be out)	In	In
m	Signal Ground to Protective Ground	In	Out
n*	Enable Remote Test	In	Out
p*	CTS Follows RTS (Strap q must be out)	In	Out
q*	CTS Follows CXR (Strap p must be out)	In	In
r	Speed Indication to DTE	In	Out
s	Enable ALB and Busy Out Control (Strap u must be out)	In	Out
t	Receive Clock to DTE	In	Out
u*	Enable Busy Out Control	Out	In
v**	Connect SCT to EIA pin 15	In	Out
w	Enable RXD During RTRT (Strap h must be out)	In	Out
a***	Inhibit postmodulator	In	Out
b***	Receiver Sensitivity -13 dBm to -48 dBm 0 dBm to -35 dBm	Out In	Out Out

* These switches and straps are forced to the standard option mode when switch A6 is Off.

** On board Rev. D, removing this strap and setting A6 OFF selects the "Standard Options" mode. On board Rev. E this strap connects the transmit clock to DTE connector pin 15.

*** Top board

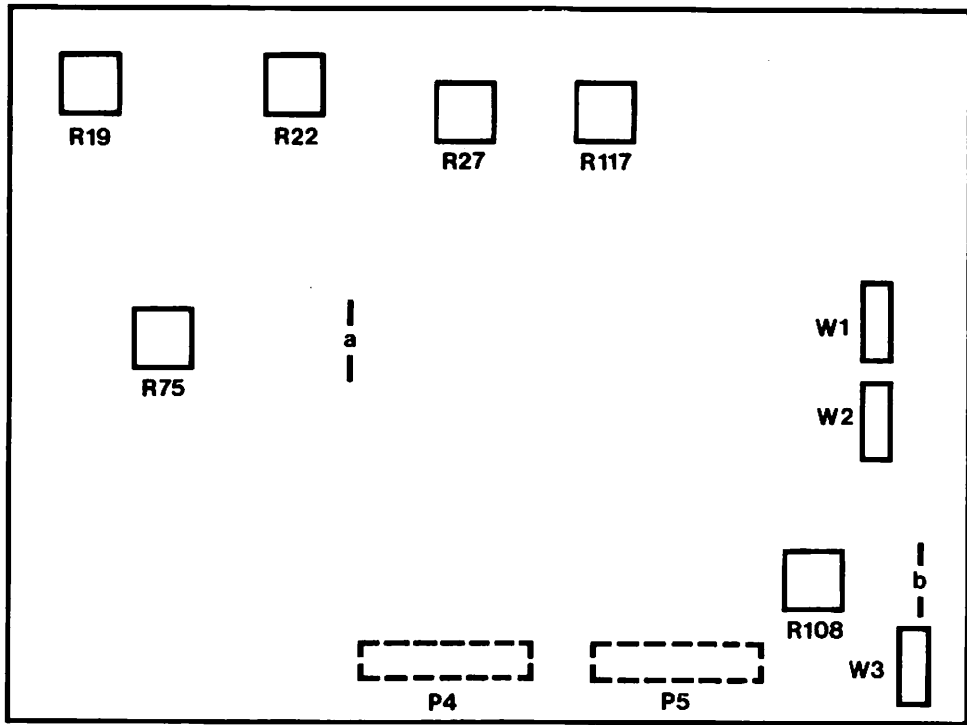

top board (81165)

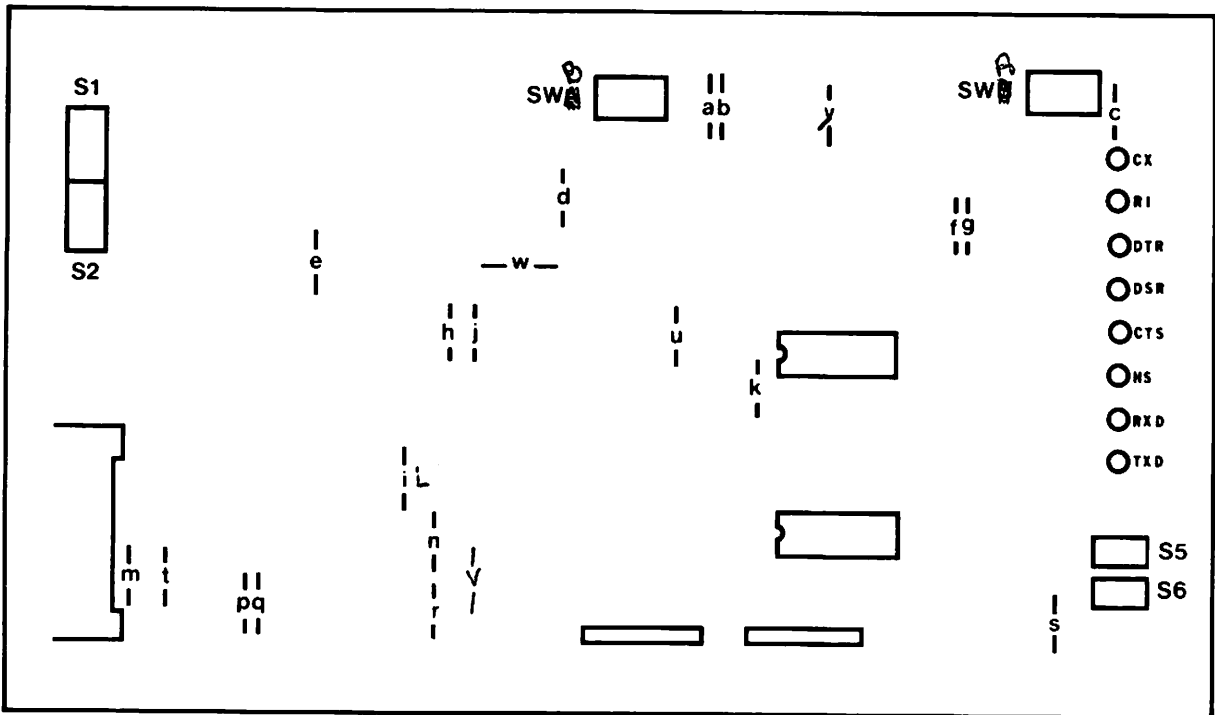

bottom board (81164)

Figure 5-1. Switch and Strap Locations

SWITCH OPTION DESCRIPTION

- A-1 When on, this option sets the modem in the manual disconnect mode. This means that the exclusion key on the telset is placed in the data position to connect a call, and the handset is not hung up until it is desired to break the connection. With this option off, the modem operates in the unattended disconnect mode. In this mode, the handset is hung up to make a connection and disconnect is controlled by loss of carrier (requires the telset to be optioned for data set control of the line) or by DTR turning OFF.
- A-2 When enabled, this option allows the modem to respond to the remote test command from a VA3400 series or 212 type modem (high speed operation only).
- A-3, A-5 This setting selects the proper character length for the transformation of asynchronous data into data character formatting. The character length option includes the start bit, information bits, parity (if used), and stop bits.

Character length is specified as follows:

A3	A5	Character Length
ON	ON	8 bits (3400 only)
OFF	ON	9 bits
ON	OFF	10 bits
OFF	OFF	11 bits (3400 only)

- A-4 When ON, this option enables 103 operation. This is available in the 3451 and 3453 models only.
- A-6 When OFF, selects standard options.
- A-7 When ON, this option enables the 1-second loss of carrier disconnect.
- B-1 When ON, the initiate remote test sequence is enabled in the 3400 and 212 modes. When off, the modem will enter local digital loopback when DLB is selected in either 3400 or 212 mode.
- B-2 When ON, the modem will internally force on Data Terminal READY.
- B-3 When ON, the modem will permanently enter the answer mode for use on one end of a 2-wire point-to-point leased line (VA3453 only).
- B-4 When ON, the internal transmit clocking is set at 1220 bps for use on time division multiplexers and any other terminal equipment which runs over-speed (3400 mode only).

- B-5 WHEN ON, this option enables the 24-second abort timer.
- B-6 When ON, the modem will be optioned for synchronous operation, allowing the transmit clock (SCT) to be presented on EIA pin 15 and the receive clock (SCR) to be present on EIA pin 17.
- B-7 When ON, this option turns Data Set Ready off in any test mode.

**SOLDER STRAP
DESCRIPTION**

- a. Enables leased-line operation (3453 only)
- b. Disables 103 and 212 response to receive space disconnect
- c. Disables 103 and 212 transmit space prior to disconnect
- d. Enables slave mode clocking for synchronous operation (connects pin 17 to pin 24)
- e. Sets transmit level to 0 dBm for leased-line operation
- f. Connects Carrier Detect (EIA pin 8) (strap g must be out)
- g. Connects Clear to Send to Carrier Detect (EIA pin 5 to pin 8) (strap f must be out)
- h. Inhibits receive data to the interface during Response to Remote Test (strap w must be out)
- j. Enables external transmit clock input for synchronous operation (EIA pin 24)
- k. Enables speed selection from EIA pin 23 (front-panel switch must be in LS position)
- l. Sets transmit level to -10 dBm for switched network (P-type connection) (e must be out)
- m. Connects Signal Ground to Chassis Ground (EIA pin 1 to pin 7)
- n. Initiate Remote Test from EIA pin 19
- p. Clear to Send following Request to Send (strap q must be out)
- q. Clear to Send follows Carrier Detect (strap p must be out)
- r. Enables speed indication (CI) to EIA pin 12

- s. When in, EIA pin 25 controls ALB and Busy Out; when out, pin 25 controls Busy Out and pin 20 is required for ALB
- t. Connects receive clock (SCR) to EIA pin 17
- u. Disables EIA pin 25 control of the Busy Out/ALB circuitry
- v. Connects transmit clock to EIA interface pin 15 (see note ** at end of Table 5-1)
- w. Enables receive data to the interface during response to remote test (strap h must be out)

**NO OPTION
MODE**

When switch A6 is OFF, the modem will enter the following configuration:

- 1. Ten-bit ASCII format
- 2. Asynchronous data mode
- 3. Abort timer disconnect enabled
- 4. Loss-of-Carrier disconnect enabled
- 5. Receive space disconnect disabled
- 6. Manual originate and automatic answer enabled
- 7. 3400 data rate at 1205 bps
- 8. Send space disconnect disabled
- 9. Originate/answer switched network
- 10. EIA pin 25 OH (busy out) disabled
- 11. DSR is on in test modes
- 12. Transmit clock from internal source
- 13. Switched network operation
- 14. Response to remote test enabled
- 15. Initiate remote test enabled
- 16. 103 mode enabled
- 17. Data rate selection from EIA pin 23 disabled
- 18. Initiate remote test (DLB) from pin 19 disabled

Section 6

SUPPLEMENTAL INFORMATION

THEORY OF OPERATION

Data Terminal Equipment Interface

The DTE interface consists of a 25-pin D-type connector located on the rear of the modem. This connector provides an RS232C connection between the modem and the terminal. The modem displays eight of these signals for diagnostic use (see Controls and Indicators section). Table 6-1 is a listing of the DTE interface connector pin assignments and their functions.

TelCo Line Interface

The VA345x modem series is supplied in a 2-wire configuration, P and S, designed to interface into switched networks. In addition, the VA3453P modem may be supplied with a VA881 adapter to allow interface into a 2-wire leased-line G configuration. The P version provides direct connection to a voice or data jack; the S version provides direct connection to a programmable data jack. Table 6-2 is a listing of TelCo interface connector pin assignments and their functions.

Table 6-1. RS232C Modem Interface Connector

Pin	Racal-Vadic Designator	EIA Designator	CCITT Designator	Function	Active State*
1	FG	AA	101	Chassis Ground	G
2	TXD	BA	103	Transmitted Data	E
3	RXD	BB	104	Received Data	E
4	RTS	CA	105	Request to Send	H
5	CTS	CB	106	Clear to Send	H
6	DSR	CC	107	Data Set Ready	H
7	SG	AB	102	Signal Ground	G
8	CXR	CF	109	Carrier Detect	H
9	+V	—	—	+12V through 1 k Ω (test)	T
10	-V	—	—	-12V through 1 k Ω (test)	T
11	—	—	—	—	—
12	CI	—	126	Speed Indication (+ 541 High, - = Low)	E
13	—	—	—	—	—
14	—	—	—	—	—
15	SCT	DB	114	Transmit Clock	E
16	—	—	—	—	—
17	SCR	DD	115	Receive Clock	E
18	—	—	—	—	—
19	RDL	—	—	Initiate Remote Test	H
20	DTR	CD	108.2	Data Terminal Ready	H
21	—	—	—	—	—
22	RI	CE	125	Ring Indicator	H
23	RSEL	CH/C1	111/112	Data Rate Select	H
24	XSCT	DA	113	External Transmit Clock	E
25	BUSY	—	—	ALB (strap option)	H

*G = Ground or common reference
H = Logic high
E = Either state active or data stream
T = Test signal

Table 6-2. TelCo Interface Cable

Leased Line Conn.	Data Jack Pin No.	Voice Jack Pin No.	Mnemonic	Function	Active State*
	1	—	—	(No Connection)	X
	2	1	—	(No Connection)	X
	3	2	MI/A	Mode Indicator Selects voice or data mode depending on state of telset exclusion switch (or other control)	L
Red	4	3	R	Ring One side of telephone line	A
Green	5	4	T	Tip Other side of telephone line	A
	6	5	MIC/AI	Mode Indicator Common Return side of MI/A signal (above)	G
	—	6	—	(No Connection)	X
	7	—	PR	Programming Resistor Resistor (on data block) used to control modem transmit level	P
	8	—	PRC	Programming Resistor Common Return side of PR signal (above)	P

- * X = Not used
- L = Active low signal
- A = Analog signal
- G = Ground or common return
- P = Passive or isolated signal

SPECIFICATIONS

INPUT DATA FORMAT

Serial, binary, synchronous, or asynchronous

INPUT DATA RATES

Synchronous

3400 or
212 Mode

1200 bps \pm 0.05%

Asynchronous

3400 Mode

1180 to 1204 bps or 1196 to 1219 bps; switch selectable.
Any standard commercial data rate 300 bps or below.

212 Mode

1182 to 1212 bps

103 Mode

0 to 300 bps

CHARACTER LENGTH

8, 9, 10, or 11 bits, switch selectable. 212 mode limited to 9 or 10 bits synchronous, 3400 subrate (0-300 bps) speeds and 103 mode are independent of character length.

MODULATION

3400 and
212 Modes

Quadrature AM (four-level PSK)

103 Mode

Binary phase-coherent FSK

ENCODING

3400	Dibit	212
90°	00	90°
270°	01	0°
180°	11	270°
0°	10	180°

SCRAMBLER ALGORITHM

$$(212 \text{ only}) Y_1 = X_1 \oplus Y_{1-14} \oplus Y_{1-17}$$

DESCRAMBLER ALGORITHM

$$(212 \text{ only}) Y_1 = Y_1 \oplus Y_{1-14} \oplus Y_{1-17}$$

TRANSMITTER

Carrier Frequencies	Originate Mode	Answer Mode
3400 Mode	2250 Hz \pm 7 Hz	1150 Hz \pm 7 Hz
212 Mode	1200 Hz \pm 7 Hz	2400 Hz \pm 7 Hz
103 Mode	1270 Hz \pm 0.2% mark 1070 Hz \pm 0.2% space	2225 Hz \pm 0.2% mark 2025 Hz \pm 0.2% space

Line Data Rate

3400 Mode	1200, 1205, or 1220 bps
212 Mode	1200 bps, \pm 0.05%
103 Mode	Equal to transmit data input, 0 to 300 bps

(NOTE: 3400 inserts extra stop bits when necessary;
212 inserts or extracts stop bits as necessary.)

Transmit Level

S Version	Per programming resistor in data jack
P Version	-10 dBm per internal programming resistor
G Version	0 dBm per internal programming

RECEIVER

Carrier Frequencies

	Answer Mode	Originate Mode
3400 Mode	2250 Hz \pm 7 Hz	1150 Hz \pm 7 Hz
212 Mode	1200 Hz \pm 7 Hz	2400 Hz \pm 7 Hz
103 Mode	1270 Hz \pm 0.2% mark 1070 Hz \pm 0.2% space	2225 Hz \pm 0.2% mark 2025 Hz \pm 0.2% space

Dynamic Range	35 dB
----------------------	-------

**Carrier Detect
Threshold**

MODES	EQUALIZER OUT	
	OFF \geq dBm	ON \leq dBm
3400 REC LO	-55.0	-48.0
3400 REC HI	-56.0	-49.0
212 REC LO	-51.0	-45.0
212 REC HI	-56.0	-50.0
103 REC LO	-51.0	-44.0
103 REC HI	-56.0	-48.0

in all modes, when the equalizer is out

CXR ON \leq -44.0 dBm

CXR OFF \geq -56.0 dBm

Hysteresis

In all modes, with the equalizer out: ≥ 1.5 dBm

Test condition for CXR threshold and hysteresis measurement:

- 1) Local transmitter sends 0 ± 1.0 dBm; "2047" or "511" pseudorandom data pattern.
- 2) Received signal in all modes is "MARK."

CXR threshold and hysteresis not tested when amplitude equalizer in.

**Carrier Detect
Timing**

	Off—On*	On—Off
3400 Mode	30 ms	280 ms
212 Mode	231-308 ms	280 ms
103 Mode	100-200 ms	280 ms

*Assumes proper mode established

**Data Rate to
Terminal**

3400 Mode	Async Mode: 1205 or 1220 bps Sync Mode: 1200 bps
212 Mode	1220 bps
103 Mode	As transmitted, 0 to 300 bps

**CLEAR TO SEND
DELAY**

3400 Mode	50 ± 10 ms after carrier detect
212 Mode	774 ± 27 ms after carrier detect
103 Mode	265 ± 60 ms after carrier detect

**AUTOMATIC
ANSWER**

Requires Data Terminal Ready and Ring Indicator; Billing Delay of 2.1 seconds ± 27 ms; Answer Tone of 2225 Hz ± 0.2% for 5 seconds

MANUAL ANSWER

MI (from handset) operates off-hook

**MODEM DETECT
ALGORITHM
ORIGINATE MODE**

1. Follows Speed Mode Switch or,
2. When controlled via pin 23, a high (+) selects "high speed" and a low (-) selects 103 operation.
3. When in high speed mode, automatically selects 3400/212 operation.

**MODEM DETECT
ALGORITHM
ANSWER MODE**

Models 3451 and 3453

- a. Send 2225 Hz, ready to detect 212 (modulated 1200 Hz), or 103 originate carrier (1270 Hz), for 4 seconds ± 10%.
- b. If no carrier detect, send 3400 low band mark, ready to detect 3400 high band mark for 4 seconds ± 10%.
- c. If no carrier detect, repeat step (a) for 10 seconds ± 10% followed by step (b) for 4 seconds ± 10%.

Model 3452

- a. Send 2225 Hz, ready to detect 212 (modulated 1200 Hz) for 4 seconds ± 10%.

- b. If no carrier detect, send 3400 low band mark, ready to detect 3400 high band mark for 4 seconds \pm 10%.
- c. If no carrier detect, repeat steps a and b.

AUTOMATIC DISCONNECTS

Abort Timer	Disconnects 22 to 24 seconds \pm 10% after billing delay and no carrier detect, switch optional.
Loss of Carrier	Disconnects in 1 second \pm 10% on loss of carrier, switch optional.
Long Space	Disconnects after 1.5 seconds \pm 10% of continuous space, switch optional.
Send Space on Disconnect	Sends 3 seconds \pm 10% of SPACE on DTR OFF or following loss of carrier (when enabled). Switch optional (DTR ON is ignored during disconnect sequence).

INTERFACE

Analog (Line)	Conforms to FCC Rules, Part 68. See Table 6-2 for pin functions.
Digital	EIA RS232C compatible. See Table 6-1 for pin functions.

DISPLAYS

TXD	Transmit Data (ON = Space)
RXD	Receive Data (ON = Space)
HS	High Speed (ON = 3400/212, OFF = 103)
CTS	Clear To Send
DSR	Data Set Ready (flashes in test mode)
DTR	Data Terminal Ready
RI	Ring Indicator/Error Detect
CXR	Carrier Detect

CONTROLS

FA	Forced Answer
HS	High Speed

DIAGNOSTICS

Idle Test

When in idle mode (on-hook and no test mode) the transmitter is turned on, both the transmitter and receiver are switched to 1200 Hz, and a scrambled dotting pattern is sent

and received. The RI lamp flashes for the following failures:

1. Errors detected
2. Failure of microprocessor circuitry

The above test is automatic and does not affect normal operation or interface signals.

Analog Loopback/ Busy Out

("Delayed" Busy Out) Turns low or high speed transmitter on (depending on mode switch), switches receiver to transmitter carrier frequency, takes modem off-hook, and isolates modem from line. ALB can be optionally DTE-initiated from pin 25. Inhibited if modem already off-hook.

Digital Loopback

Local digital loopback (near end) is available in 103 mode only by DLB switch on rear panel. Remote digital loopback (far end) may be initiated in the 3400 and 212 mode via DLB switch on rear panel. Local response to remotely initiated digital loopback unless optionally inhibited.

SELF TEST

Unsquels transmitter and inputs scrambled dotting pattern (high speed) or dotting pattern (low speed) into transmitter. Looks for errors in high speed or 25% distortion in low speed.

ENVIRONMENTAL DATA

Operating Temperature Range

0° to 50°
(32° to 122° F)

Storage Temperature Range

-20° to 70°
(-4° to 158° F)

Maximum Relative Humidity

90% without condensation

POWER REQUIREMENTS

117 V ac \pm 10%, 47 to 63 Hz
12 watts maximum

PHYSICAL DATA

Height: 2.55 inches (65 mm)
Width: 7 inches (178 mm)
Depth: 12 inches (305 mm)

WARRANTY, LIMITATION OF LIABILITY AND SERVICE INFORMATION

RACAL-VADIC INC. warrants that its products will perform in accordance with RACAL-VADIC's published specifications (or the specification agreed to, in writing, by Buyer and RACAL-VADIC INC., and made a part of the sales contract), for a period of 12 months from date of original shipment.

During this warranty period, RACAL-VADIC INC. will, at no cost, promptly repair or replace any defective equipment returned to RACAL-VADIC INC., transportation charges prepaid by Buyer, and will return such equipment, transportation charges prepaid via the same or like method as received, except where special handling or shipment is requested by Buyer, in which case Buyer shall pay all such charges.

This warranty shall not apply to damage resulting from abuse, negligence, accident or loss or damage in transit. The warranty shall be voided should the Buyer attempt any repairs or alterations without prior written permission of RACAL-VADIC INC.

RACAL-VADIC INC. makes no other warranty, expressed or implied, and RACAL-VADIC INC. DISCLAIMS ANY IMPLIED WARRANTY OF MERCHANTABILITY OR FITNESS FOR A PARTICULAR PURPOSE.

THE BUYER AND RACAL-VADIC INC. AGREE THAT THE SOLE AND EXCLUSIVE REMEDIES FOR BREACH OF ANY WARRANTY CONCERNING THE GOODS SHALL BE REPAIR OR REPLACEMENT OF DEFECTIVE PARTS UPON THE TERMS ABOVE DESCRIBED OR, AT RACAL-VADIC INC. OPTION, REFUND OF THE PURCHASE PRICE. RACAL-VADIC INC. SHALL NOT BE LIABLE FOR CONTINGENT OR CONSEQUENTIAL DAMAGES TO PERSONS OR PROPERTY AND ITS SOLE LIABILITY IS AS ABOVE SET FORTH.

Any action by Buyer for any alleged breach of the warranty set forth herein shall be brought to the attention of RACAL-VADIC INC. by Buyer within the warranty period, but not later than 30 days after the alleged Breach.

THIS STATEMENT OF WARRANTY AND LIMITATION OF LIABILITY IS A COMPLETE AND EXCLUSIVE STATEMENT OF ALL WARRANTY AND LIABILITY REPRESENTATIONS OF RACAL-VADIC INC. It may not be varied, supplemented, qualified or interpreted by any prior dealings between the parties or by any usage of the trade or upon the face or reverse of any form to which this is attached or a part of, nor may it be modified by any agent, employee or representative of RACAL-VADIC INC. unless such modification or representation is made in writing and signed by a duly authorized officer of RACAL-VADIC INC.

Repairs and/or replacement under the terms of this warranty SHALL NOT EXTEND THE WARRANTY LIFE OF THE ORIGINAL EQUIPMENT SUPPLIED.

Equipment returned to the factory should be accompanied by the following information: the reason for return, with a comprehensive description of the malfunction; shipping instructions; and the name and telephone number of a contact in the event of problems. Further inquiries may be directed to RACAL-VADIC's Customer Service Departments listed below.

RACAL-VADIC INC.
18W100-22nd STREET, Suite 124
Oakbrook Terrace, Illinois 60181
Phone: (312) 932-9268

RACAL-VADIC INC.
16 Lakeside Office Park
Wakefield, Massachusetts 01880
Phone: (617) 245-8790

* RACAL-VADIC INC.
4720L Boston Way
Lanham, Maryland 20801
Phone: (301) 459-7430

RACAL-VADIC INC.
2715 Avenue E East, Suite 618
Arlington, Texas 76011
Phone: (817) 277-2246

*RACAL-VADIC INC.
222 Caspian Drive
Sunnyvale, California 94086
Phone: (408) 744-1727

*Repair Center Location

International Representatives

Argentina
 Bahamas
 Bahrain
 Bolivia
 Botswana
 Brazil
 Canary Islands
 Chile
 Colombia
 Costa Rica
 Cyprus
 Denmark
 Dominican Republic
 Ecuador
 Egypt
 El Salvador
 Finland
 Ghana
 Greece
 Guam
 Guatemala
 Haiti
 Honduras
 Iceland
 India
 Indonesia
 Ireland
 Israel
 Italy
 Ivory Coast
 Japan
 Jordan
 Kenya
 Korea
 Kuwait
 Lebanon
 Liberia
 Malaysia
 Malta
 Mexico
 Morocco
 New Guinea
 Nicaragua
 Nigeria
 Norway
 Paraguay
 Peru
 Philippines
 Portugal
 Qatar
 Saudi Arabia
 Scotland
 Senegal
 South Africa
 Spain
 Sri Lanka
 Sudan
 Tasmania
 Thailand
 Turkey
 United Arab Emirates
 Uruguay
 Venezuela
 Zimbabwe

United States

Alabama Birmingham Mobile	Florida Coral Gables Hialeah Hollywood Jacksonville Miami Orlando Sarasota Tampa	Iowa Ankeny Kansas Overland Park Wichita Kentucky Louisville Louisiana Baton Rouge Metairie Maine Portland Maryland Baltimore Bethesda Gaithersburg Rockville Massachusetts Boston Burlington Chelmsford Lawrence Littleton Lowell Methuen Tewksbury Worcester Michigan Grand Rapids Kalamazoo Lansing	Southfield Minnesota Eden Prairie Minneapolis Mississippi Jackson Missouri Creve Coeur St. Louis Nebraska Omaha Nevada Las Vegas New Hampshire Manchester New Jersey Bloomfield Clifton Edison Mountainside Toms River New Mexico Albuquerque Santa Fe New York Albany Jericho Lake Success New York City Rochester	Syosset Syracuse Tonawanda North Carolina Charlotte Greensboro Raleigh Ohio Akron Cincinnati Cleveland Independence Toledo Worthington Oklahoma Oklahoma City Tulsa Oregon Eugene Portland Salem Pennsylvania Allentown Erie Harrisburg Philadelphia Pittsburgh State College Wayne Rhode Island Providence	South Carolina Charleston Columbia Tennessee Chattanooga Knoxville Memphis Nashville Texas Austin Dallas El Paso Houston San Antonio Utah Salt Lake City Virginia Newport News Norfolk Richmond Rosslyn Springfield Washington Richland Seattle Spokane Wisconsin Appleton Brookfield Green Bay Madison Wauwatosa
--	---	---	--	--	--

International Offices

Australia Wang Computer Pty., Ltd. Adelaide, S.A. Brisbane, Qld. Canberra, A.C.T. Perth, W.A. South Melbourne, Vic 3 Sydney, NSW	China Wang Industrial Co., Ltd. Taipei Wang Laboratories, Ltd. Taipei	France Wang France S.A.R.L. Paris Bordeaux Lille Lyon Marseilles Nantes Nice Rouen Strasbourg	Japan Wang Computer Ltd. Tokyo Netherlands Wang Nederland B.V. IJsselstein Groningen New Zealand Wang Computer Ltd. Auckland Christchurch Wellington	Malmö Switzerland Wang A.G. Zurich Basel Bern Geneva Lausanne St. Gallen Wang Trading A.G. Zug West Germany Wang Deutschland, GmbH Frankfurt Berlin Cologne Düsseldorf Essen Freiburg Hamburg Hannover Kassel Mannheim Munich Nürnberg Saarbrücken Stuttgart
Austria Wang Gesellschaft, m.b.H. Vienna Belgium Wang Europe, S.A. Brussels Erpe-Mere Canada Wang Canada Ltd. Burlington, Ontario Burnaby, B.C. Calgary, Alberta Don Mills, Ontario Edmonton, Alberta Halifax, Nova Scotia Hamilton, Ontario Montreal, Quebec Ottawa, Ontario Quebec City, Quebec Toronto, Ontario	Great Britain Wang (U.K.) Ltd. Richmond Birmingham London Manchester Hong Kong Wang Pacific Ltd. Hong Kong	Panama Wang de Panama (CPEC) S.A. Panama City Puerto Rico Wang Computadoras, Inc. Hato Rey Singapore Wang Computer (Pte) Ltd. Singapore Sweden Wang Skandinaviska AB Stockholm Gothenburg		

WANG

ONE INDUSTRIAL AVENUE, LOWELL, MASSACHUSETTS 01851, TEL. (617) 459-5000, TWX 710 343-6769, TELEX 84-7421

PRINTED IN U.S.A.